

GC7□ Series Pressure Gauges







OUTLINE

This is a digital type pressure gauge, applicable for wider measuring materials, in which a semiconductor strain gauge is installed to the pressure sensing portion because it has been showing durability and stability.

An appropriate model due to the type of indications, outputs and installing methods can be selected by taking into consideration the type of applications. Two types of sensor portion is available : the directly connected type and the separate type. So, selection according to applied conditions and required sensor type is possible.

* Only the directly connected type is manufactured for GC74 and GC77.



Model	GC70	GC72	GC73	GC74	GC75	GC77
Outward form						
Mounting	Stem mounting Surface mounting Panel mounting (Mounting clamp)	Stem mounting Surface mounting	Panel mounting (Mounting clamp)	Stem mounting Surface mounting	Stem mounting Surface mounting	Stem mounting Panel mounting (Mounting clamp)
Indication	3 1/2 digit LCD display (Height of letter: 15mm)	3 1/2 digit LED display (Height of letter:14.2mm)	3 1/2 digit LED display (Height of letter: 14.2mm)	3 1/2 digit Large-sized LCD display (Height of letter:17.8mm)	3 1/2 digit LED display (Height of letter:14.2mm)	3 digit LCD display (With backlight)
Power source	24V DC Alkaline Dry cell × 3 pcs (Battery type)	24V DC	24V DC 100V AC 200V AC	Alkaline Dry cell × 3 pcs (Battery type)	24V DC	24V DC
Output	Comparator output Relay contact output (24V DC), Open collector output (Battery type)	Comparator output Relay contact output, Open collector output Or analog output 4 ~ 20mA DC, 1 ~ 5V DC	Comparator output Relay contact output, Open collector output Analog output (Option) 4 ~ 20mA DC, 1 ~ 5V DC	—	Comparator output Relay contact output, Open collector output Or analog output 4 ~ 20mA DC, 1 ~ 5V DC	Comparator output Open collector output Analog output (Option) 4 ~ 20mA DC, 1 ~ 5V DC
Construction	Indoor use	Indoor use	Indoor use	Drip-proof	Drip-proof	Indoor use

GC70 Digital pressure gauge

GC74 Drip-proof digital pressure gauge

SPECIFICATION

Mounting:

Stem mounting, Surface mounting, Panel mounting (GC70 only)

Sensor part mounting:

Direct type, Separate type

Operating condition:

Under the normal condition, where there is no inflammable gas or liquid which cause the ignition or explosion.

Connection:

G1/4B (PF), G3/8B (PF), G1/2B (PF), R1/4 (PT), R3/8 (PT), R1/2 (PT)

* R□ screw is available up to 50MPa

Wetted parts material:

O-ring type ***** Sealed with O-ring, so well performing the seal

Diaphragm material 630st.st. (17-4PH)

Socket 316st.st.

O-ring material NBR

Welding type *** By EB welding, completely sealed.

(1MPa or over)

Diaphragm material 630st.st. (17-4PH)

Socket 316st.st.

Pressure range:

0 ~ 0.3 → 0 ~ 100MPa (0 ~ 3 → 0 ~ 1000kgf/cm²)

-0.1 ~ 0.3 → -0.1 ~ 2MPa (-1 ~ 3 → -1 ~ 20kgf/cm²)

Max. allowable pressure:

200% of pressure range

(35,50MPa is 150%, 70,100 MPa is 120%)

Operating temperature:

GC70 0 ~ 40°C (Prohibited dew condensation)

GC74 0 ~ 50°C (Prohibited dew condensation)

Storage temperature:

GC70 -20 ~ 60°C

GC74 -20 ~ 70°C

Power source:

24V DC 25mA (GC70 only External source),

Alkaline Dry cell × 3 pcs (Battery type)

Comparator output: (GC70 only)

Output contents *****

Relay contact output

110V AC, 0.2A (External source)

(Inductive load cos = 0.4, L/R = 7ms)

Open collector output

30V, 80mA DC max. (Battery type)

Number of output ***** Independence two contact

Pressure setting range • Dead-band *** Free in pressure range

Accuracy:

±0.5%F.S.±1digit

(Except 0.3MPa or less and 70MPa or over)

±1.0%F.S.±1digit

Temperature coefficient: (Zero • Span)

±0.05%F.S./°C (At accuracy ± 0.5 % F.S.)

±0.1% F.S./°C (At accuracy ±1.0% F.S.)

Hold function: (Option)

GC70 min.value, max.value

Simultaneous indication of pressure measurement value

* But comparator function (Output) is deleted.

GC74 Changing hold value and measurement value by switch.

Sampling time: (GC70 only)

0.5s or 0.1s (External source only)

Pressure indication:

3 1/2 digit LCD display

Hight of letter GC70 15mm

GC74 17.8mm

Display interval 0.5s

Case material:

Stem • Surface mounting: Aluminum die casting

Panel mounting: Glass reinforced plastic

Construction:

GC70 Indoor use

GC74 Drip-proof (Equivalent to IP54)

Weight:

GC70 Approx. 400g

GC74 Approx. 430g

EXAMPLE OF COMPARATOR OUTPUT GC70 only

Example of relay output

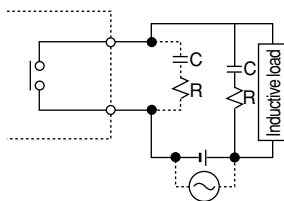

In case of inductive load, insert contact protection circuit in parallel to load or contact. It is effective even if uses varistor instead of CR.

Example of open collector output

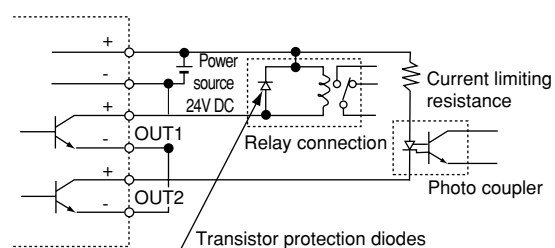

GC73 Panel type digital pressure gauge GC77 Small digital pressure gauge

Type No. constitution

Please specify Type No., each specification and range when ordering.

Note: For this Model, there is no applicable item for figures X, but please specify X when ordering.

Construction	Sensor part	Display	Output
Indoor use	Direct type 3 Panel mounting Separate type 3 Panel mounting	3 1/2 digit LED display	Comparator output Relay contact output or Open collector output Analog output (Option)
Drip-proof	Direct type 1 Stem mounting 3 Panel mounting	3 digit LCD display (With backlight)	Comparator output Open collector output Analog output (Option)

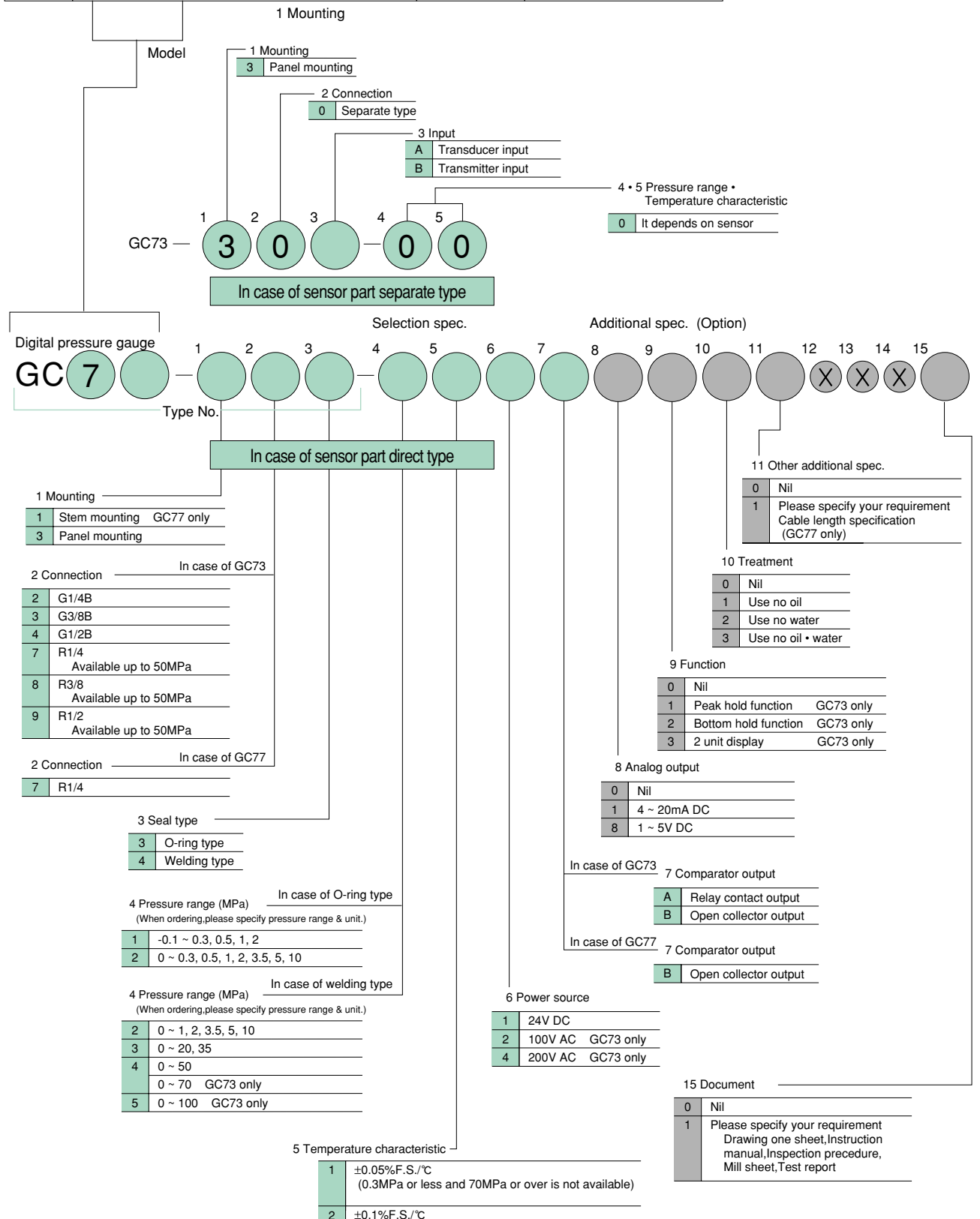

GC72 Digital pressure gauge GC75 Drip-proof digital pressure gauge

Type No. constitution

Please specify Type No.,each specification and range when ordering.

Note: For this Model, there is no applicable item for figures X,but please specify X when ordering.

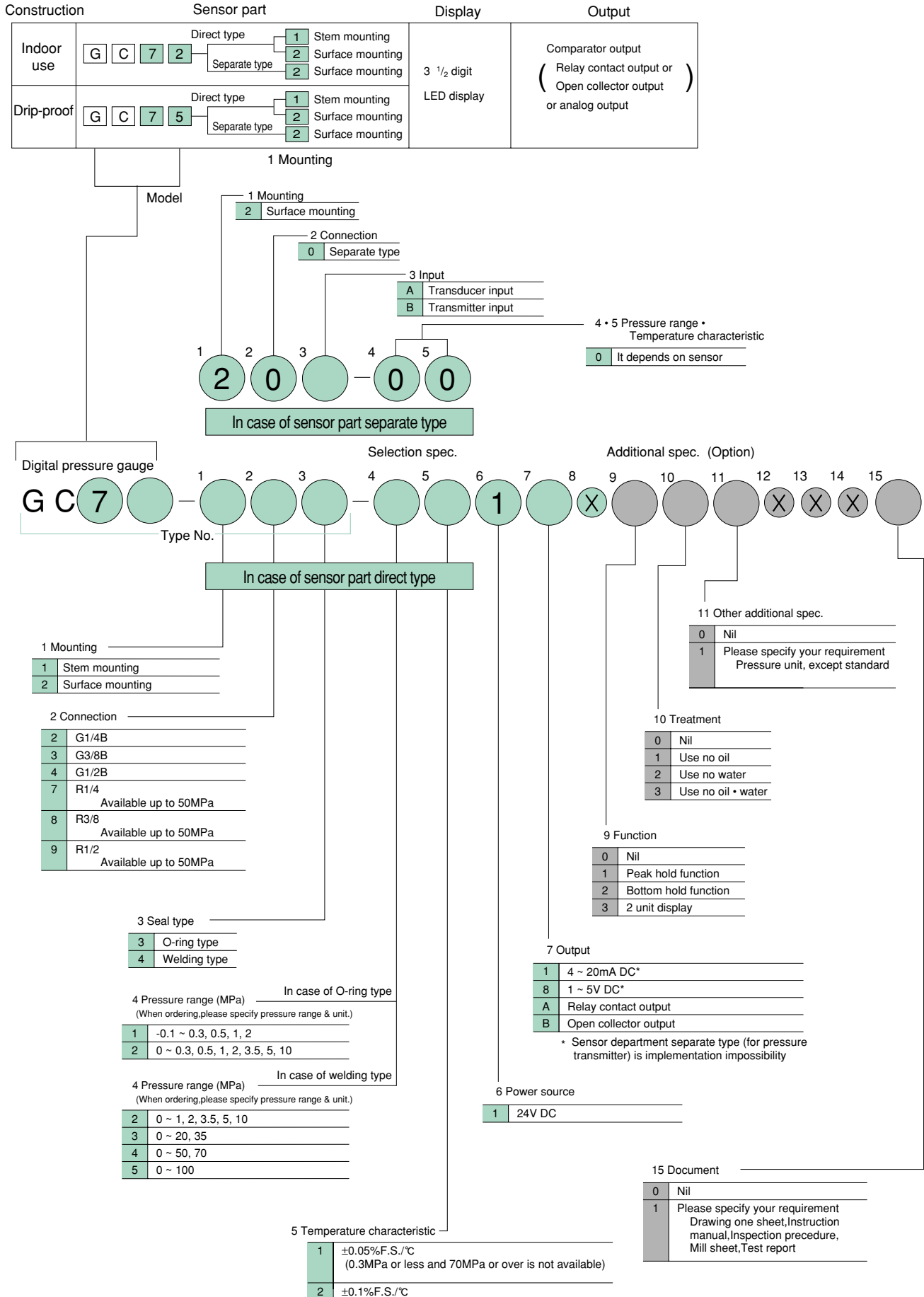

DIMENSIONS

GC70 Stem • Surface mounting

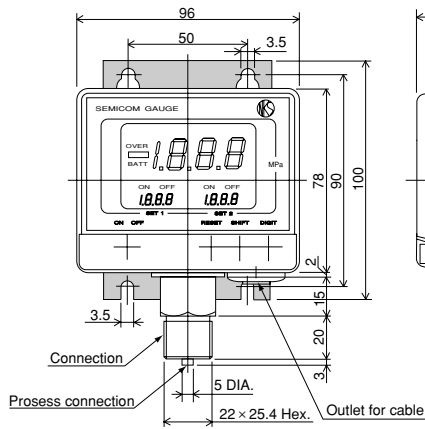

Sensor parts, separate type

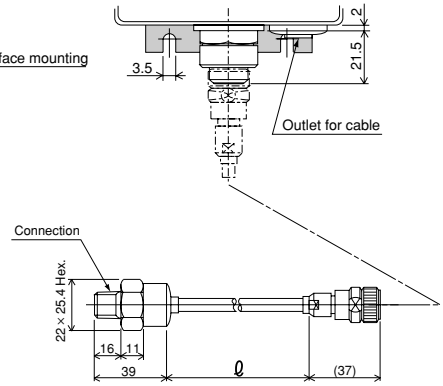

(Sensor part is KH17 cable type, KH15 connector type, KH27, KH25 connector type Silicon type of KH17, KH15 is not applicable. Sensor parts of above figure is cable type of KH17.)

GC70 Panel type

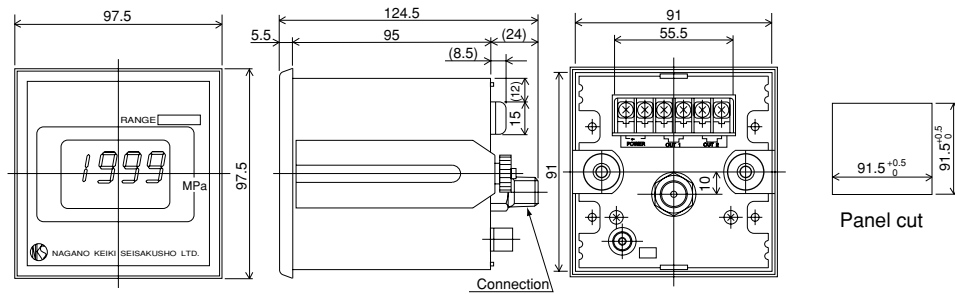

Sensor parts, separate type

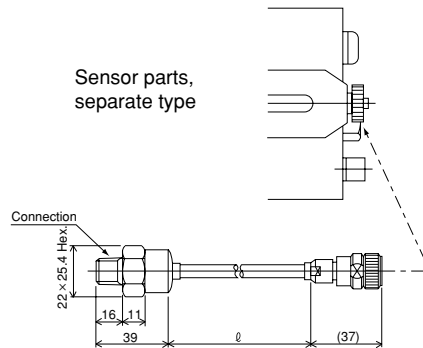

(Sensor part is KH17 cable type, KH15 connector type, KH27, KH25 connector type Silicon type of KH17, KH15 is not applicable. Sensor parts of above figure is cable type of KH17.)

GC74 Stem • Surface mounting

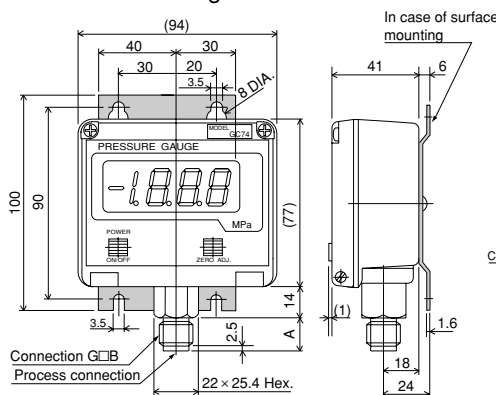

Mounting screw loss example □B

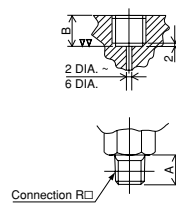

Sensor parts separate type

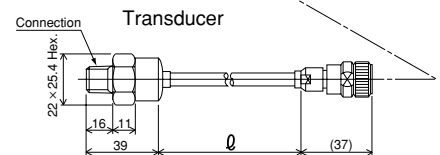
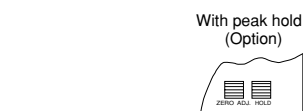
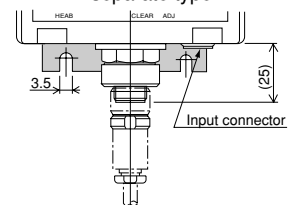

Connection	G ¹ / ₄ B	G ³ / ₈ B	G ¹ / ₂ B	R ¹ / ₄	R ³ / ₈	R ¹ / ₂
A (mm)	16	18	20	16	18	20
B (mm) (Reference)	15	17	19	—	—	—

GC72 Digital pressure gauge

GC75 Drip-proof digital pressure gauge

SPECIFICATION

Mounting:

Stem mounting, Surface mounting

Sensor part mounting:

Direct type, Separate type

Operating condition:

Under the normal condition, where there is no inflammable gas or liquid which cause the ignition or explosion.

Connection:

G1/4B (PF), G3/8B (PF), G1/2B (PF), R1/4 (PT), R3/8 (PT), R1/2 (PT)

* R□ screw is available up to 50MPa

Wetted parts material:

O-ring type ***** Sealed with O-ring, so well performing the seal

Diaphragm material 630st.st. (17-4PH)

Socket 316st.st.

O-ring material NBR

Welding type *** By EB welding, completely sealed

(1MPa or over)

Diaphragm material 630st.st. (17-4PH)

Socket 316st.st.

Pressure range:

0 ~ 0.3 → 0 ~ 100MPa (0 ~ 3 → 0 ~ 1000kgf/cm²)

-0.1 ~ 0.3 → -0.1 ~ 2MPa (-1 ~ 3 → -1 ~ 20kgf/cm²)

Max. allowable pressure:

200% of pressure range

(35,50MPa is 150%, 70,100MPa is 120%)

Operating temperature:

0 ~ 50°C (Prohibited dew condensation)

Storage temperature:

-20 ~ 70°C

Power source:

24V DC±5% 60mA DC max.

Comparator output:

Output contents ***** (Either only)

Relay contact output

110V AC, 0.2A (Resistance load)

Open collector output

30V, 80mA DC max.

Number of output ***** Independence two contact

Response ***** Within 10ms

Pressure setting range, dead band ***** Free in pressure range

Analog output:

4 ~ 20 mA DC or 1 ~ 5 V DC

Response ***** Within 1ms

Load resistance ***** 400Ωmax. (Current output)

10kΩmin. (Voltage output)

* Separate type of sensor parts (for pressure transmitter) is not available

Accuracy:

±0.5%F.S.±1digit

(Except 0.3MPa or less and 70MPa or over)

±1.0%F.S.±1digit

Temperature coefficient: (Zero • Span)

±0.05%F.S./°C (At accuracy ±0.5 % F.S.)

±0.1%F.S./°C (At accuracy ±1.0 % F.S.)

Function: (Option)

Hold function Changing hold value and measurement value by switch.

2 unit display Change by switch

Pressure display:

3 1/2 digit LED display (Height of letter 14.2mm)

Display interval Approx. 0.2s

Case material:

Aluminum die casting

Construction:

GC72 Indoor use

GC75 Drip-proof (Equivalent to IP54)

Weight:

GC72 Approx. 400g

GC75 Approx. 430g

* Output

Either comparator output or analog output.

EXAMPLE OF OUTPUT

Example of relay output

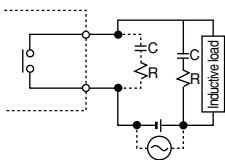

In case of inductive load, insert contact protection circuit in parallel to load or contact. It is effective even if uses varistor instead of CR.

Example of open collector output

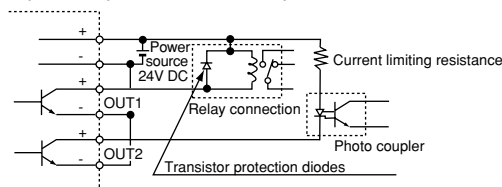

Example of analog output

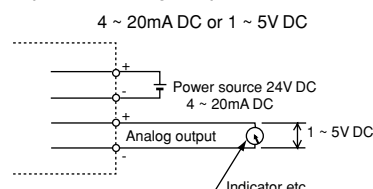

GC70 Digital pressure gauge GC74 Drip-proof digital pressure gauge

Type No. constitution

Please specify Type No., each specification and range when ordering.

Note: For this Model, there is no applicable item for figures X, but please specify X when ordering.

Construction	Sensor parts	Display	Output
Indoor use	Direct type: 1 Stem mounting, 2 Surface mounting, 3 Panel type mounting Separate type: 2 Surface mounting, 3 Panel type mounting	3 1/2 digit LCD display	Comparator output Relay contact output (24V DC) Open collector output (Battery type)
Drip-proof	Direct type: 1 Stem mounting, 2 Surface mounting Separate type: 2 Surface mounting		No function

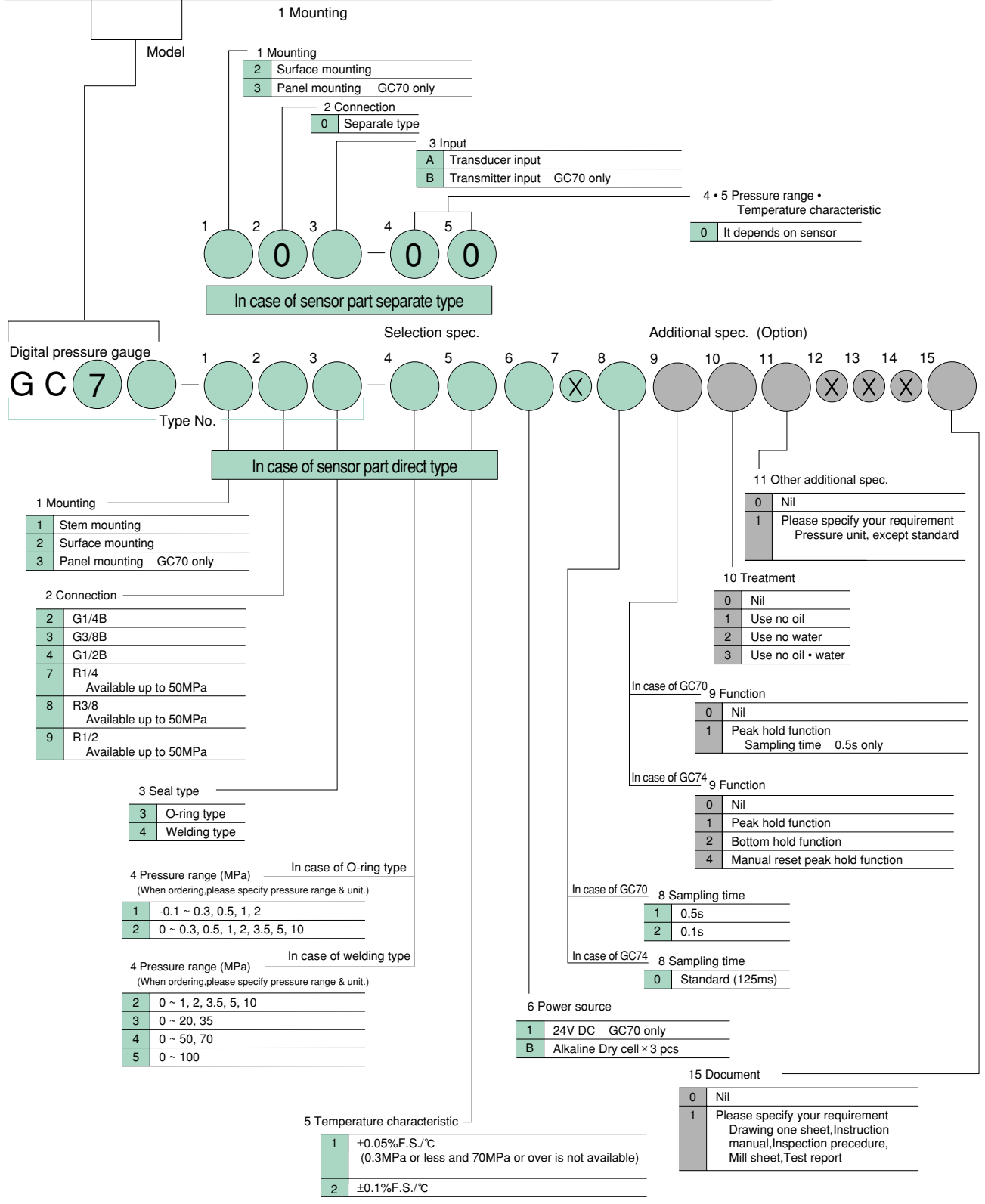

GC77 Small digital pressure gauge

SPECIFICATION

Mounting:

Stem mounting, Panel mounting

Sensor part mounting:

Direct type

Operating condition:

Under the normal condition, where there is no inflammable gas or liquid which cause the ignition or explosion.

Connection:

R1/4 (PT)

Wetted parts material:

O-ring type Sealed with O-ring, so well performing the sea

Diaphragm material 630 st.st. (17-4PH)

Socket 316 st.st.

O-ring material NBR

Welding type ... By EB welding, completely sealed.

(1MPa or over)

Diaphragm material 630 st.st. (17-4PH)

Socket 316 st.st.

Pressure range:

0 ~ 0.3 → 0 ~ 50MPa (0 ~ 3 → 0 ~ 500kgf/cm²)

-0.1 ~ 0.3 → -0.1 ~ 2MPa (-1 ~ 3 → -1 ~ 20kgf/cm²)

Max. allowable pressure:

200% of pressure range

(35,50MPa is 150%)

Operating temperature:

-10 ~ 60°C (Prohibited dew condensation)

Storage temperature:

-20 ~ 70°C

Power source:

24V DC±20% 35mA DC max.

Comparator output:

Output contents
 Open collector output 30V, 80mA DC max.

Number of contact One contact

Response Within 10ms

Upper limit operation (or lower limit operation),

Dead band Free in pressure range

Operation indication LED display (ON lighting)

Analog output: (Option)

4 ~ 20 mA DC or 1 ~ 5 V DC

Output accuracy ±1%F.S.

Response Within 1ms

Load resistance 400Ωmax. (Current output),
 10kΩmin. (Voltage output)

Accuracy:

±1.0%F.S.±1digit

Temperature coefficient: (Zero + Span)

±0.05%F.S./°C (It removes 0.3MPa range)

±0.1%F.S./°C

Pressure indication:

3 digit LCD display (Height of letter 6mm)

Display interval Approx. 0.2s

Case material:

Denaturation polyphenylene ether resin

Construction:

Indoor use

Weight:

Approx. 100 g

EXAMPLE OF OUTPUT

Example of open collector output

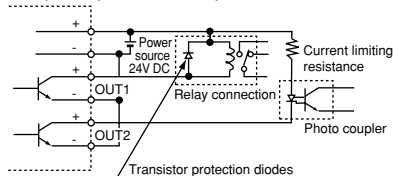

Example of analog output (Option)

4 ~ 20mA DC or 1 ~ 5V DC

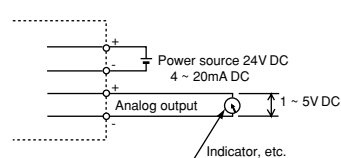

DIMENSIONS

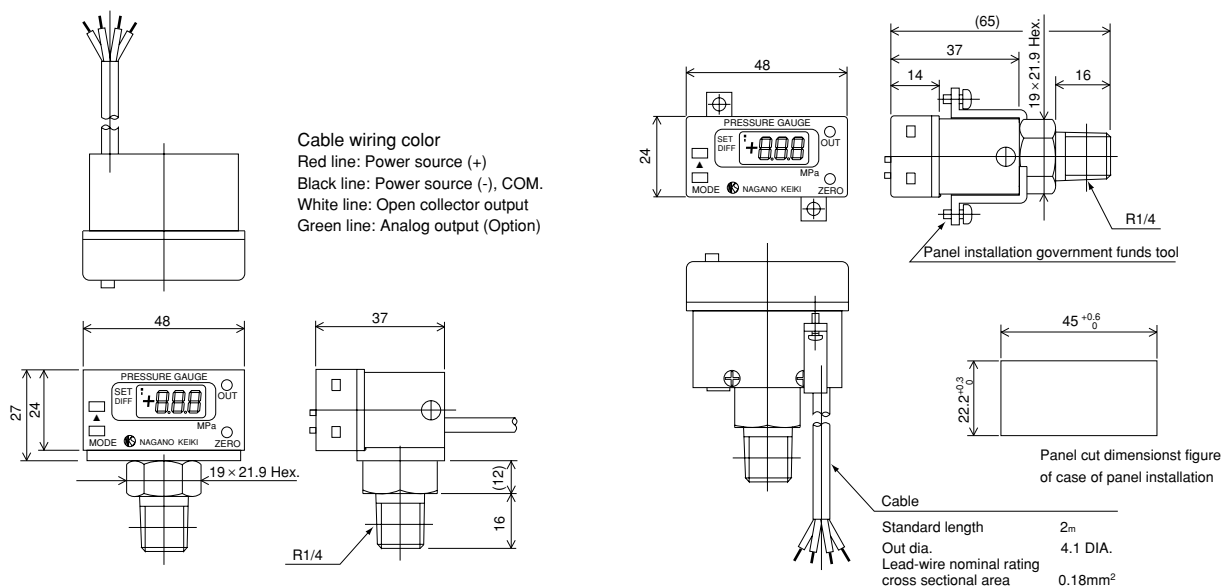

DIMENSION

GC72 Stem • Surface mounting

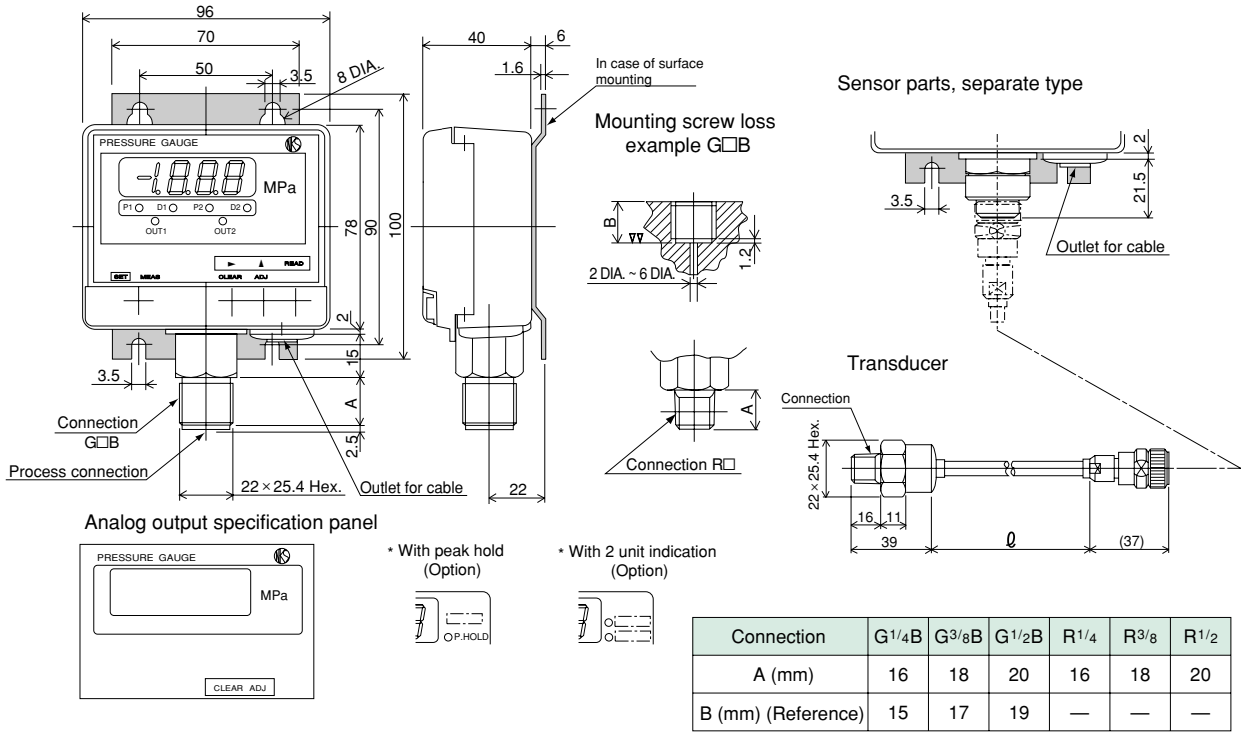

GC75 Stem • Surface mounting

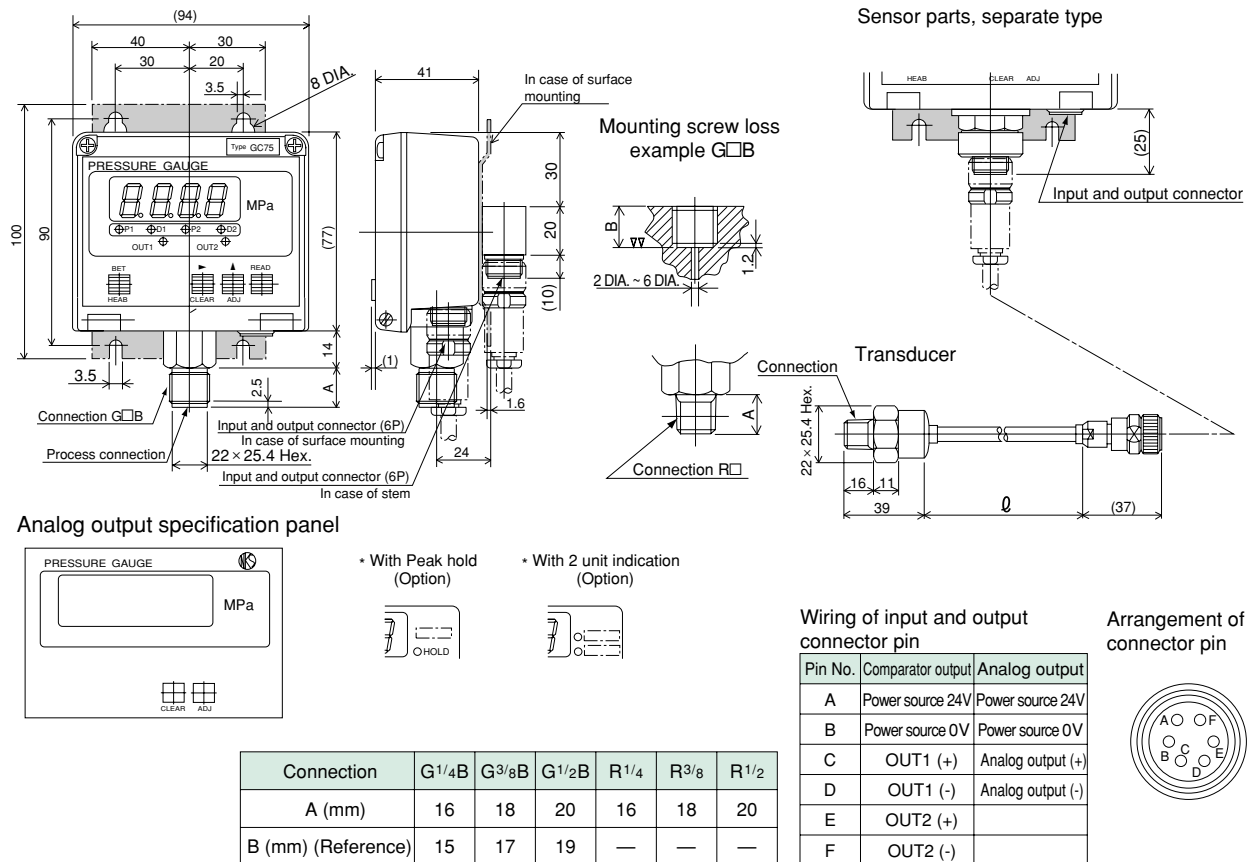

GC73 Panel form digital pressure gauge

SPECIFICATION

Mounting:

Panel mounting

Sensor part mounting:

Direct type, Separate type

Operating condition:

Under the normal condition, where there is no inflammable gas or liquid which cause the ignition or explosion.

Connection:

G1/4B (PF), G3/8B (PF), G1/2B (PF), R1/4 (PT), R3/8 (PT), R1/2 (PT)

* R□ screw is available up to 50MPa

Wetted parts material:

O-ring type ***** Sealed with O-ring, so well performing the seal

Diaphragm material 630st.st. (17-4PH)

Socket 316st.st.

O-ring material NBR

Welding type *** ByEB welding, completely sealed

(1MPa or over)

Diaphragm material 630st.st. (17-4PH)

Socket 316st.st.

Pressure range:

0 ~ 0.3 → 0 ~ 100MPa (0 ~ 3 → 0 ~ 1000kgf/cm²)

-0.1 ~ 0.3 → -0.1 ~ 2MPa (-1 ~ 3 → -1 ~ 20kgf/cm²)

Max. allowable pressure:

200% of pressure range

(35,50MPa is 150%,70,100 MPa is 120%)

Operating temperature:

0 ~ 50°C (Prohibited dew condensation)

Storage temperature:

-20 ~ 70°C

Power source:

24V DC, 100V AC or 200V AC

Comparator output:

Output contents ***** (Either 1 or 2)

1. Relay contact output

200V AC, 2A (Resistance load)

2. Open collector output

30V, 80mA DC max.

Number of output ***** Independence two contact

Response ***** Within 10ms

Pressure setting range, dead band ***** Free in pressure range

Analog output: (Option)

4 ~ 20mA DC or 1 ~ 5V DC

Response ***** Within 1ms

Load resistance ***** 400Ωmax. (Current output)

10kΩmin. (Voltage output)

Accuracy:

±0.5%F.S.±1digit

(Except 0.3MPa or less and 70MPa or over)

±1.0%F.S.±1digit

Temperature coefficient: (Zero • Span)

±0.05%F.S./°C (At accuracy ± 0.5 % F.S.)

±0.1%F.S./°C (At accuracy ± 1.0 % F.S.)

Function : (Option)

Hold function Changing hold value and measurement value by switch

2 unit display Change by switch

Pressure indication:

3 1/2 digit LED display (Hight of letter 14.2mm)

Display interval Approx. 0.2 s

Case material:

SPCC

Construction:

Indoor use

Weight:

Approx. 800 g (Direct type, At the time of 24V DC)

EXAMPLE OF OUTPUT

Example of relay output

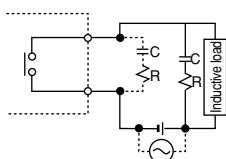

In case of inductive load, insert contact protection circuit in parallel to load or contact. It is effective even if uses varistor instead of CR.

Example of open collector output

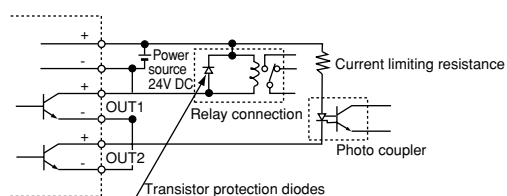

Example of analog output

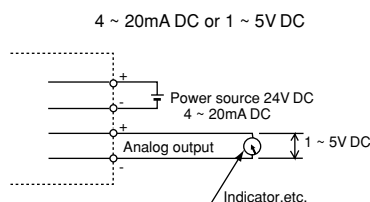

DIMENSIONS

GC73 Panel

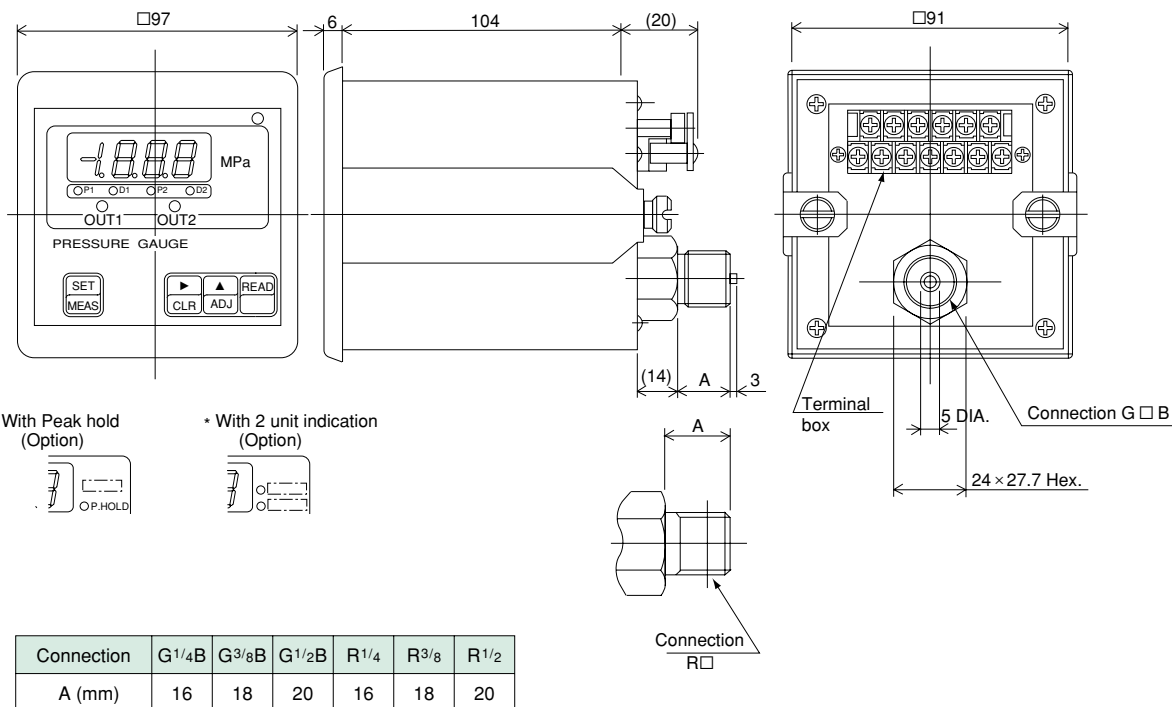

Sensor parts, separate type

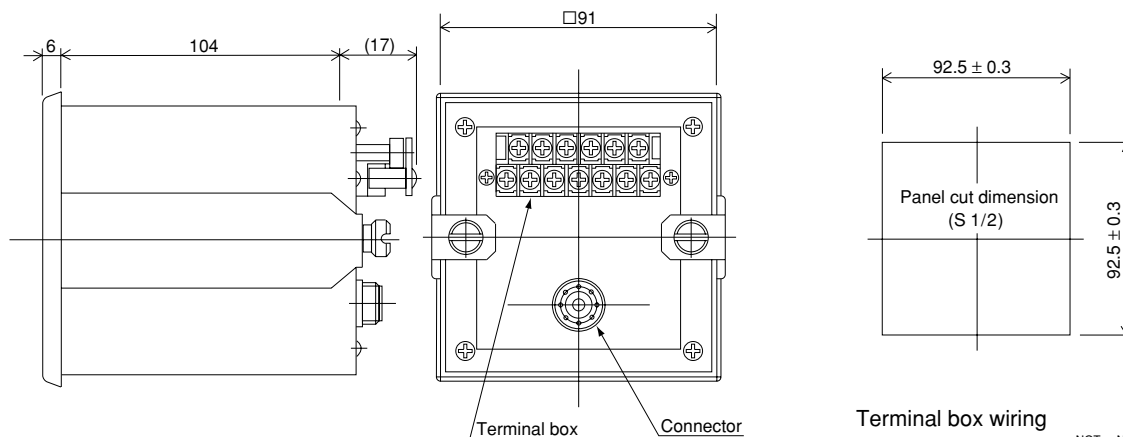

Terminal box wiring

